



# Grader Blades for Earth Moving and Snow Removal

# GRADER BLADES



# Grader Blades

Kennametal offers the widest selection and the most innovative designs of road maintenance tools available in the industry, including carbide blades, grader blades, snowplow blades, and accessories. With our expertise in highly complex metallurgy and materials science, we optimize performance and significantly decrease production costs.

To learn more about our road maintenance offerings and find a solution that best meets your needs, contact your local Kennametal Representative or Authorized Distributor.

**MISSION** Kennametal delivers productivity to customers seeking peak performance in demanding environments by providing innovative custom and standard wear-resistant solutions, enabled through our advanced materials sciences, application knowledge, and commitment to a sustainable environment.







## Table of Contents

Scarifier Blades .....	6–23
Dual-Carbide Blades .....	24–27
I.C.E.™/KenCoat™ Blades .....	28–29
KenCoat™ Blades .....	30–31
Armored Blades .....	32–33
Grader Blades for Snow Removal .....	34–35

# Grader Blades

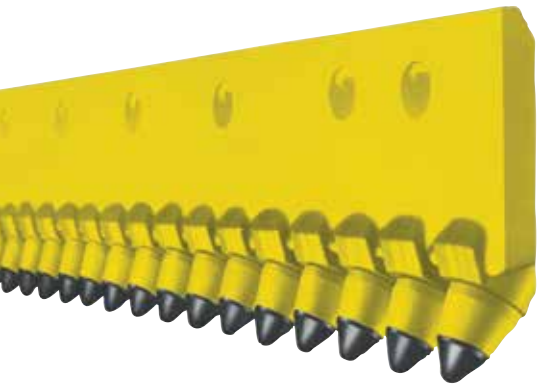

## Scarifier Blades

- Penetrates hard-packed gravel and frozen surfaces easily with less down pressure and horsepower.
- Eliminates “washboarding” and pot holes with fewer passes than standard blades.
- Decreases the number of passes necessary to properly maintain a road surface.
- Features replaceable, rotating, self-sharpening, solid carbide-tipped cutting tools that wear uniformly and last longer than all-steel blades.
- Reduces machine and operator downtime significantly by eliminating the need to replace entire blade sections and instead, allowing for the quick change of individual tools.

## Dual-Carbide Blades

- Provides maximum wear resistance.
- Features two tungsten carbide inserts, specifically designed for high-abrasion and low-impact applications.
- Outlasts imbedded carbide granule-style blades.
- Offers the longest lasting blade life span in the industry.
- Reduces costs associated with replacement part inventory, downtime, labor, and overall operations.
- Resists “crowning” and maintains a straighter cutting edge throughout the life of the blade.

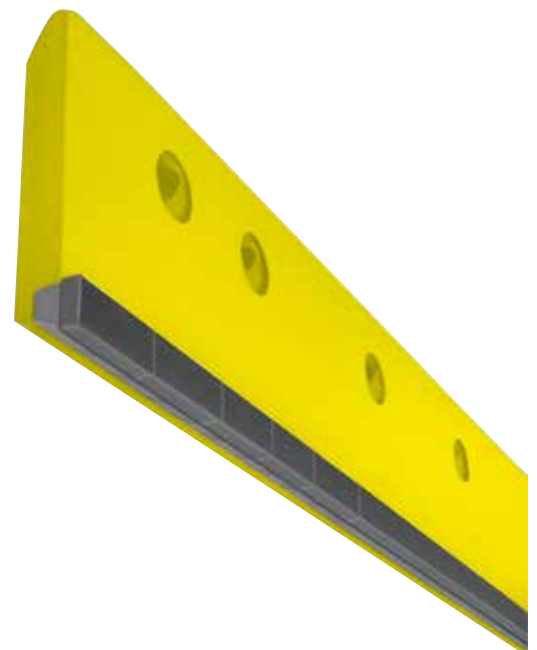

# Grader Blades

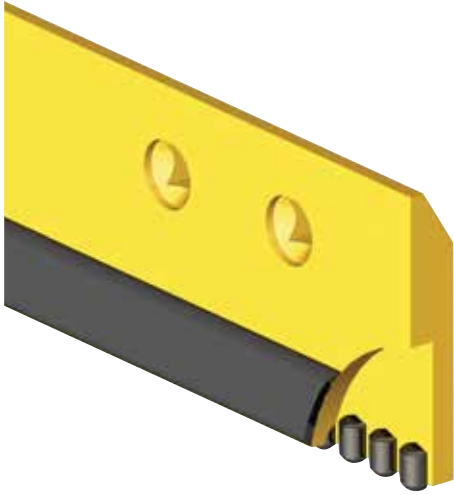

## I.C.E.™/KenCoat™ Blades

Combining Isolated Carbide-Edge (I.C.E.) Blades and Kennametal Carbide Overlay Application Technology (KenCoat)

- Combines durable, individually mounted bullet-shaped inserts with wear-resistant carbide granules embedded in a tough, abrasion-resistant, steel-weld material in one blade.
- Features optimal levels of blade wear, impact, and fracture resistance.
- Designed specifically for maximum performance and blade longevity.
- Performs effectively in snow removal operations on roads with embedded lane markers and rumble strips.
- Withstands high-speed plowing over excessive joints, major cracks, and uneven road surfaces.

## KenCoat™ Blades

Kennametal Carbide Overlay Application Technology

- Economical choices for moderate-impact applications.
- Resists wear from down pressure.
- Provides wear life 3–5x greater than standard carbide blades.
- Features wear-resistant carbide granules embedded in an abrasion-resistant, steel-weld material that offers better protection of the solid carbide insert in the blade.
- Available in both 1" (25mm) and 1.50" (38mm) wide KenCoat protection.



# Grader Blades

---

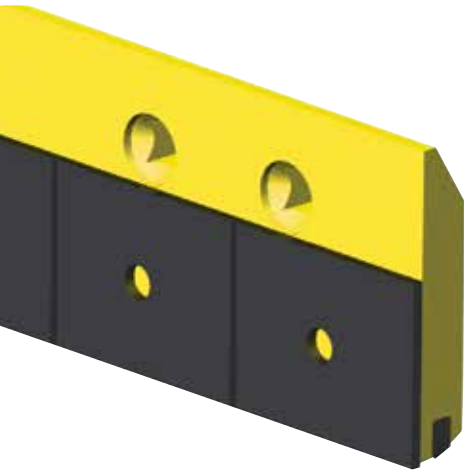

## Armored Blades

- Economical choices for higher-impact applications.
- Offers wear life 3–5x greater than standard carbide blades.
- Protects carbide insert by reinforcing the mild steel face with a securely welded hardened-steel plate.
- Available in 3ft (914mm), 4ft (1219mm), and 5ft (1524mm) lengths.

## Grader Blades for Plowing Snow

- Offers unparalleled combination of fracture and wear resistance.
- Our brazing expertise ensures that inserts stay firmly in place, without residual stress, resulting in a more durable blade.
- Available in an unmatched variety of styles and sizes — each backed by the road maintenance industry's best quality assurance program.
- Sold in combinations of 3ft (914mm) and 4ft (1219mm) lengths for more versatility, safety, and ease of use.

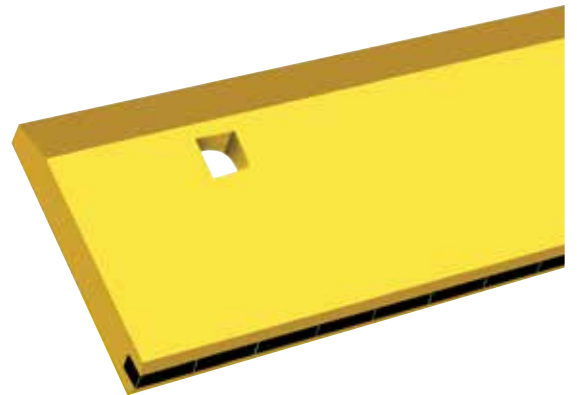





# FOR THE MOST DEMANDING APPLICATIONS

To learn more about our wear and tooling solutions for grader blades contact your Kennametal Representative or Authorized Kennametal Distributor today.



# Scarifier Blades

## Carbide-Tipped Cutting Tools, Blocks, and Accessories for Scarifier Blade Systems

Kennametal's exclusive tungsten carbide-tipped cutting tools outlast all steel blades. Featuring rotating, self-sharpening cutting tools for more uniform wear and longer tool life, Kennametal blades provide exceptional cutting action in demanding, tough surfaces, including hard-packed gravel roads and frozen ground.

Blades maintain an even cutting height by enabling cutting tools to be rotated from position to position. This significantly reduces machine and operator downtime by enabling operators to individually change worn cutting tools without using special tools, and without replacing entire blade sections and bolts — within a matter of minutes.

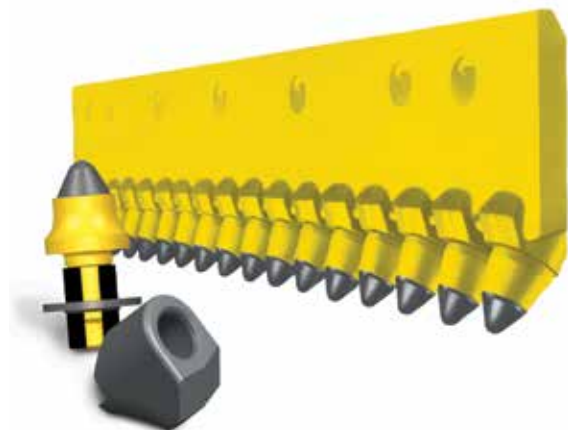

Our cutting tools and blocks are proven in:

- Dirt and gravel road maintenance.
- Hard-packed snow and ice removal.
- Chip and seal road reclamation.
- Tar sand road reclamation.
- Spot asphalt milling.
- Spreading loose material.
- Mixing calcium chloride, magnesium chloride, or other dust suppressants.



# A Variety of Blade Styles to Match Your Conditions

Kennametal blades are easier to use and more versatile than competitive systems. The attack angle of the cutting tools is preset for ease of use, optimum tool rotation, and performance. Kennametal systems also accept a wider variety of cutting tool styles including both rotating and non-rotating type tools to handle a wider variety of conditions.

Kennametal's scarifier blade systems are designed so that just the cutting tools get replaced, not the blades. Partially worn cutting tools can be easily repositioned along the moldboard to maintain a straighter edge and achieve balanced cutting tool wear life. A single person can change an entire set of cutting tools in a matter of minutes, even in the field, with no special tools required!

Kennametal scarifier blades are available in three different styles, specifically designed to perform optimally in a range of ground conditions from light to the harshest of applications:

- **Standard-Duty Blades** — Ideal for light-use road grading in average conditions and applications.
- **Heavy-Duty Blades** — Generally ideal for road grading in most conditions and applications.
- **Severe-Duty Blades** — Ideal for grading in extreme road conditions and applications. Feature a 6" (152mm) blade width instead of the 5" (127mm) width of standard- and heavy-duty blades for more clearance between the toolholder blocks on the back of the blade and the "frog" of the moldboard. Include extra-heavy welds to reduce block breakout from the blade.

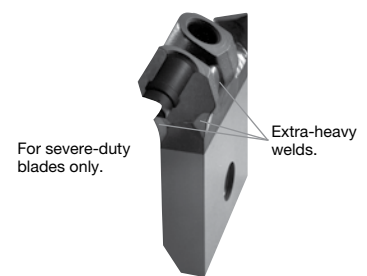

Weld chamfers around block pockets increase weld strength.

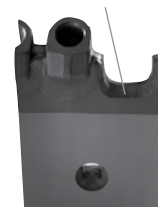

Use the following table to determine the length and number of blades required to outfit your grader with a scarifier system. The length of your moldboard determines how many 3ft (914mm) or 4ft (1219mm) blade sections you will need.

■ Blade Selection Guide for Various Moldboards Lengths

length of moldboard	size and quantity of scarifier blade sections required for (1) moldboard assembly		number of cutting tools required
	3ft. (914mm) sections	4ft. (1219mm) sections	
12ft. [144" (3658mm)]	0	3	72
13ft. [156" (3962mm)]	3	1	78
14ft. [168" (4267mm)]	2	2	84
16ft. [192" (4877mm)]	0	4	96

NOTE: Kennametal recommends the use of Grade 8, Number 3 head-plow bolts and nuts when installing blades.

Upon determining the length and number of scarifier blades required, use the following specifications table to determine the specific style of scarifier blade — standard, heavy, and/or severe duty — that you need. This chart can also be used to determine the number of cutting tools required.

■ Scarifier Blade Sizes and Ordering Information

thickness		width		length		blade type	bolt diameter		new order number	quantity of cutting tools required	approximate weight	
in	mm	in	mm	in	mm		in	mm			kg	lbs
.875	22	5	127	36	914	standard duty	.625	16	1012359	18	23	50
.875	22	5	127	48	1219	standard duty	.625	16	1012360	24	32	70
.875	22	5	127	36	914	standard duty	.750	19	1012361	18	23	50
.875	22	5	127	48	1219	standard duty	.750	19	1012362	24	32	70
1.25	32	5	127	36	914	heavy duty	.625	16	1012351	18	29	65
1.25	32	5	127	48	1219	heavy duty	.625	16	1012352	24	39	86
1.25	32	5	127	36	914	heavy duty	.750	19	1012354	18	29	65
1.25	32	5	127	48	1219	heavy duty	.750	19	1012353	24	39	86
1.25	32	6	152	36	914	severe duty	.625	16	1083322	18	37	81
1.25	32	6	152	48	1219	severe duty	.625	16	1083323	24	49	109
1.25	32	6	152	36	914	severe duty	.750	19	1013086	18	37	81
1.25	32	6	152	48	1219	severe duty	.750	19	1013087	24	49	109

NOTE: The above blades feature conical toolholder blocks positioned on 2" (51mm) centers. All blades are punched in a heavy-duty standard highway punch pattern. This means that the last two holes of each blade are on 3" (76mm) centers with the rest of the holes on 6" (152mm) centers. Kennametal scarifier blades can be used in combination to fit virtually every make and model of motor grader manufactured.

# Cover Blades

Kennametal's optional cover blades provide exceptional wear resistance and superior protection of the main blade body. We recommend using our wear-resistant steel cover blades when the scarifier system is operating in extremely abrasive conditions or when carrying heavy debris loads on the moldboard. The new, redesigned cover blade features an improved design that better protects the blocks and welds. Made of more wear-resistant steel and thicker than our previous models, these new cover blades attach easily through existing bolt holes on the blade using bolts that are .750" (19mm) longer than those used to attach the scarifier blade to the moldboard. Cover blade sections can be changed without changing the entire scarifier blade.

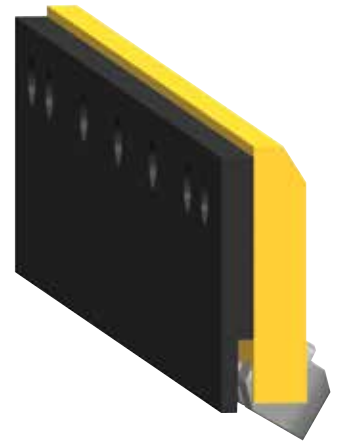

## ■ Cover Blades Ordering Information • Standard-Duty Blades

thickness		width		length		order number	bolt diameter	
in	mm	in	mm	in	mm		in	mm
.750	19	5	127	36	914	<b>1810486</b>	.625	16
.750	19	5	127	48	1219	<b>1803906</b>	.625	16
.750	19	5	127	36	914	<b>1810484</b>	.750	19
.750	19	5	127	48	1219	<b>1810485</b>	.750	19

## ■ Cover Blades Ordering Information • Severe-Duty Blades

thickness		width		length		order number	bolt diameter	
in	mm	in	mm	in	mm		in	mm
.750	19	6	152	36	914	<b>1791493</b>	.625	16
.750	19	6	152	48	1219	<b>1791494</b>	.625	16
.750	19	6	152	36	914	<b>1799128</b>	.750	19
.750	19	6	152	48	1219	<b>1799131</b>	.750	19



# End Protectors

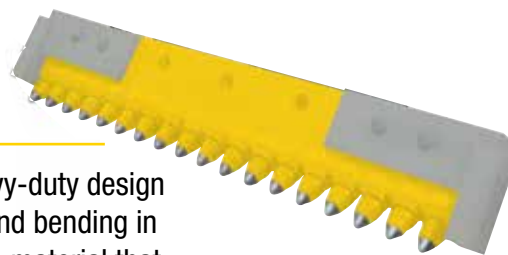

Kennametal carbide end protectors for scarifier blades feature a heavy-duty design and tough steel supports of the end protectors that resist breakage and bending in any road application. Our end protectors feature KenCast™ composite material that combines the wear resistance of Kennametal’s exclusive tungsten carbide with the ductility of air-hardening steel.

## For standard- and heavy-duty blades

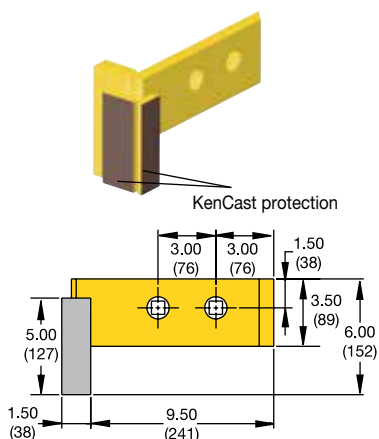

## For severe-duty blades

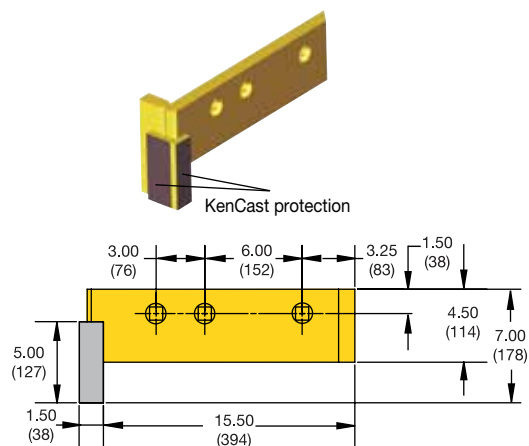

### ■ End Protectors Ordering Information • Standard-Duty Blades

bolt design	description	bolt diameter		order number	catalog number	approximate unit weight	
		in	mm			kg	lbs
2-bolt design for standard- and heavy-duty systems	right-hand end protector	.625	16	1012885	KCWB-0348	5	10
2-bolt design for standard- and heavy-duty systems	left-hand end protector	.625	16	1012884	KCWB-0349	5	10
2-bolt design for standard- and heavy-duty systems	right-hand end protector	.750	19	1012911	KCWB-0350	5	10
2-bolt design for standard- and heavy-duty systems	left-hand end protector	.750	19	1012912	KCWB-0351	5	10

### ■ End Protectors Ordering Information • Severe-Duty Blades

bolt design	description	bolt diameter		order number	catalog number	approximate unit weight	
		in	mm			kg	lbs
2-bolt design for severe-duty systems	right-hand end protector	.750	19	1718695	KCWB-0415	10	21
2-bolt design for severe-duty systems	left-hand end protector	.750	19	1718697	KCWB-0416	10	21
3-bolt design for severe-duty systems	right-hand end protector	.750	19	1821674	KCWB-0442	11	25
3-bolt design for severe-duty systems	left-hand end protector	.750	19	1821679	KCWB-0443	11	25

- Superior wear and rotation.
- Washer keeps out debris and improves rotation for longer bit life and less block wear.
- New full-sleeve retainer protects the inside of the bore to prevent uneven wear.
- Washer precompresses the retainer which makes it easier to install.
- Retainer grips tighter to prevent bit loss.

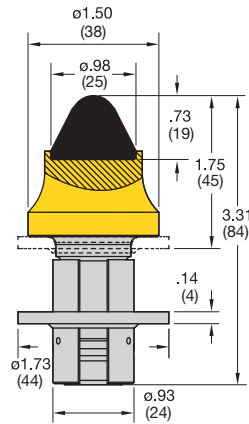

**C87WFRKCSB**

order number	catalog number
2041786	C87WFRKCSB

- Economy-sized carbide tip.
- Washer keeps out debris and improves rotation for longer bit life, less block wear.
- Full sleeve retainer protects inside of the bore to prevent uneven wear.
- Washer precompresses the retainer for easier installation.
- Retainer grips tighter to prevent bit loss.

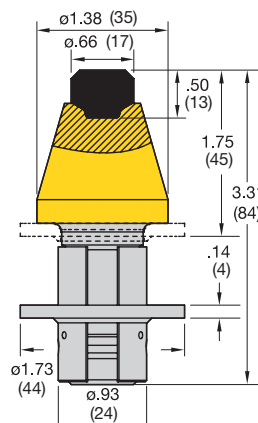

**C87HDRP**

order number	catalog number
3837213	C87HDRP

**Packaging Information**

order number	catalog number	pieces per container	container weight (approximate)	
			kg	lbs
2041786	C87WFRKCSB	50	.38	.841
3837213	C87HDRP	50	.34	.756

Dimensions shown in millimeters and (inches).

- Longest wearing carbide tip available.
- For use on all types of road surfaces.
- Specially designed carbide tip for extra-long tool life and added steel-wash protection.
- 1.45" (37mm) diameter cutting tool shoulder protects block face from excessive wear.

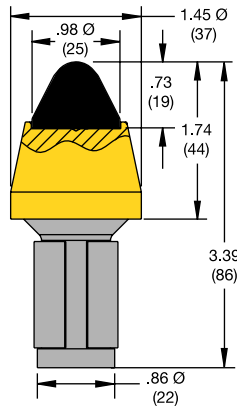

■ **C858KCSB**

order number	catalog number
1010880	C858KCSB

- Same design as C858KCSB with added "barbed" short retainer for improved cutting tool retention.

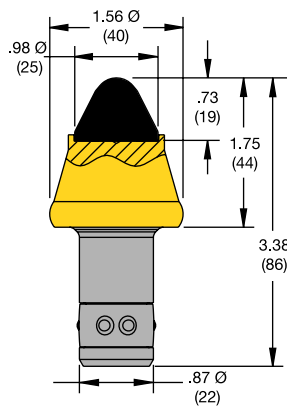

■ **C87KCSBSR**

order number	catalog number
1010937	C87KCSB SR

■ **Packaging Information**

order number	catalog number	pieces per container	container weight (approximate)	
			kg	lbs
1010880	C858KCSB	50	.38	.840
1010937	C87KCSB SR	50	.37	.815

Dimensions shown in millimeters and (inches).



- Sharper carbide tip for increased penetration.
- Large carbide tip for long tool life in average cutting conditions.
- Specially designed flange protects block from excessive wear.
- Puller groove for easier tool extraction from front side of blade.

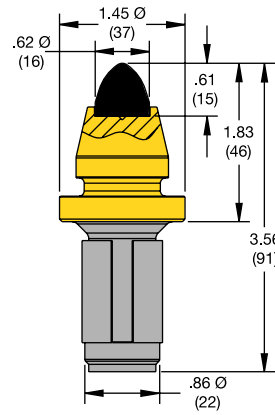

■ **C387DS**

order number	catalog number
1010906	C387DS

- Same tip design as C387DS but shank features “barbed” short retainer for improved retention in block.
- Larger steel body provides longer wear life.

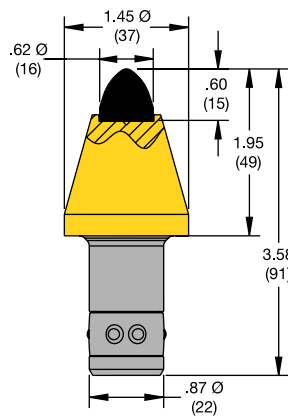

■ **C87DSSR**

order number	catalog number
1010935	C87DS SR

■ **Packaging Information**

order number	catalog number	pieces per container	container weight (approximate)	
			kg	lbs
1010906	C387DS	50	.31	.674
1010935	C87DS SR	50	.35	.772

Dimensions shown in millimeters and (inches).

- Larger carbide tip than similar competitive tools.
- Improved with 30% stronger braze.
- Blunt-nose tip style.
- Fits competitive blade systems.

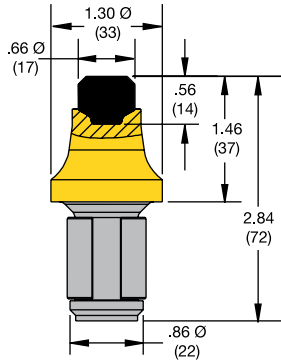

■ **C855HD**

order number	catalog number
1011208	C855HD

- Larger carbide tip than similar competitive tools.
- Improved with 30% stronger braze.
- Same body style as C855HD but with added steel for increased strength and wear life.
- Fits Kennametal and competitive blade systems.

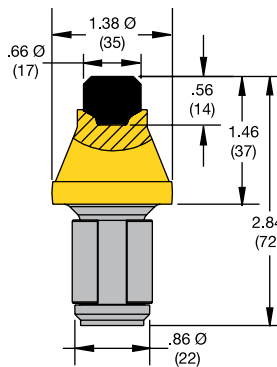

■ **C855HDX**

order number	catalog number
1011206	C855HDX

■ **Packaging Information**

order number	catalog number	pieces per container	container weight (approximate)	
			kg	lbs
1011208	C855HD	50	.24	.540
1011206	C855HDX	50	.27	.597

Dimensions shown in millimeters and (inches).

- Economy-sized carbide tip.
- Improved with 30% stronger braze.
- Additional steel in body style for added strength and wear life.
- Fits Kennametal and competitive blade systems.

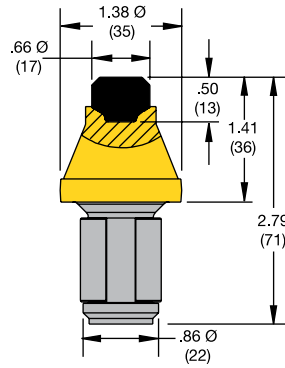

■ **C855HDX-4**

order number	catalog number
3386038	C855HDX-4

- Designed for maximum wear life and durability like the C858KCSB but made to fit Kennametal and some competitive blade systems.
- Longer gage length for reduced wear on blades and blocks.
- Ideal for general-duty and heavy-impact applications.

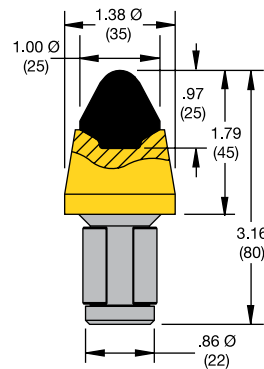

■ **C855KCSB**

order number	catalog number
1855704	C855KCSB

■ **Packaging Information**

order number	catalog number	pieces per container	container weight (approximate)	
			kg	lbs
3386038	C855HDX-4	50	.26	.570
1855704	C855KCSB	50	.35	.780

Dimensions shown in millimeters and (inches).



- Sharp carbide tip.
- Fits Kennametal and competitive blade systems.

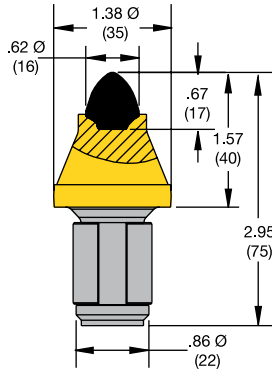

■ **C855LR**

order number	catalog number
1011001	C855LR

- For fine grading or scarifying in soft to medium-hard conditions, or for scraping without penetrating road surface.
- 1-1/2" (38mm) cutting face width for better block protection.
- Swept-back carbide edge design provides exceptional tool life.
- Non-rotating tool (not self-sharpening).
- Wider tool face reduces gap between cutting tools for smooth, grooming applications.

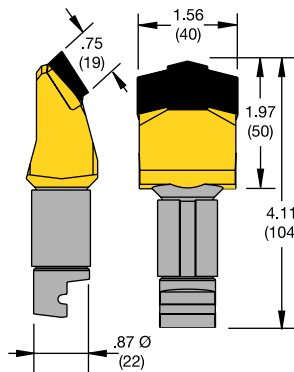

■ **AR15087**

order number	catalog number
1012240	AR15087

■ **Packaging Information**

order number	catalog number	pieces per container	container weight (approximate)	
			kg	lbs
1011001	C855LR	50	.25	.544
1012240	AR15087	40	.45	1.000

Dimensions shown in millimeters and (inches).

- Specially designed and manufactured for use in competitive “mining duty” systems. (This tool does NOT fit Kennametal blade systems.)
- Contains more carbide than similar competitive designs.

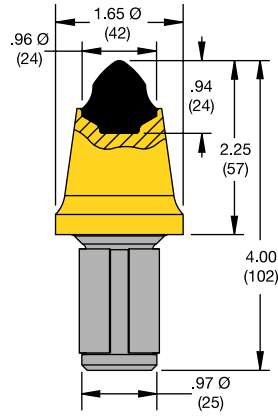

■ **C100 24.43SB**

order number	catalog number
1847237	C100 24.43SB

- Replacement toolholder for Kennametal blade systems.
- Easily welded with a 7018 or 8018 low-hydrogen rod with no pre-heating required.

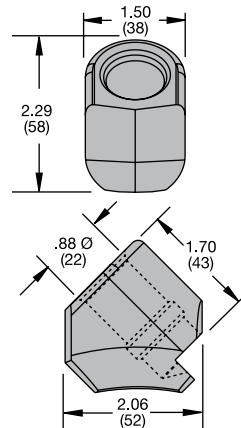

■ **C87GB Block**

order number	catalog number
1012234	C87G BLOCK

■ **Packaging Information**

order number	catalog number	pieces per container	container weight (approximate)	
			kg	lbs
1847237	C100 24.43SB	25	.54	1.180
1012234	C87G BLOCK	30	.43	.950

Dimensions shown in millimeters and (inches).

- Sharp pointed tip for easy penetration of hard surfaces.
- Excellent in soft to medium-hard abrasive conditions.
- Specially designed flange protects block face from excessive wear.
- Ideal for removing high spots and washboard effect on asphalt-paved roads.

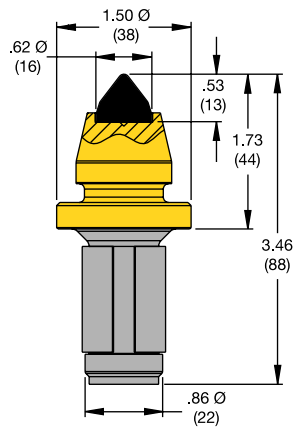

■ **C387BF**

order number	catalog number
1010817	C387BF

■ **Packaging Information**

order number	catalog number	pieces per container	container weight (approximate)	
			kg	lbs
1010817	C387BF	50	.30	.659

Dimensions shown in millimeters and (inches).

■ **KHP2 Hammer Punch**

- For removing cutting tools from blocks.
- Hardened tip for longer life; used with a hammer.
- Plastic hand protector for added safety.

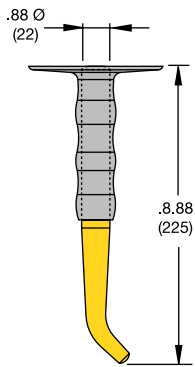

order number	catalog number
1012247	KHP2 Hammer Punch

■ **KAHP1 Air-Hammer Punch**

- For removing cutting tools from blocks.
- Hardened tip for durability.
- Fits all light-duty, air-hammer guns that have a .375" (10mm) chuck.

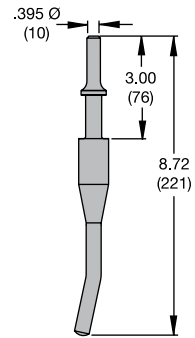

order number	catalog number
1012245	KAHP1 Air-Hammer Punch

■ **KAHP 1D Air-Hammer Punch**

- For removing cutting tools from blocks.
- Hardened tip for durability.
- Fits all heavy-duty, air-hammer guns that have a .500" (13mm) chuck.

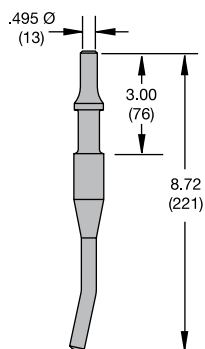

order number	catalog number
1012246	KAHP 1D Air-Hammer Punch

■ **LR87**

- Replacement retainer for use with C387DS, AR15087, C387BF, KCWB-0448, and C87BF cutting tools.



order number	catalog number
1011935	LR87

■ **C87SR**

- Replacement retainer for use with C87KCSBSR and C87DSSR cutting tools.



order number	catalog number
1012363	C87SR

■ **LR858**

- Replacement retainer for use with C858KCSB.



order number	catalog number
1012089	LR858

■ **SR Washer 44MM**

- Replacement washer for C87WFRKCSB.



order number	catalog number
1992068	SR Washer 44MM



■ **RPR07 Retainer**

- Replacement retainer for C87WFRKCSB.



order number	catalog number
1990418	RPR07 Retainer

■ **LR85**

- Replacement retainer for use with C855DS, C855HD, C855HDX, C855LR, C855KCSB, and C855HDX-4 cutting tools.

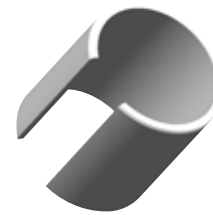

order number	catalog number
1012117	LR85

■ **C100SB**

- Replacement retainer for use with C100 24.43SB cutting tools.



order number	catalog number
1851733	C100SB

■ **Reducer Bushing**

- Reduces bolt hole size in blades from .750" (19mm) bolt to .625" (16mm) bolt.

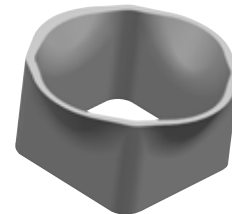

order number	catalog number
1104522	Reducer Bushing

## Guidelines for Proper Use of Scarifier Blades

---

**These guidelines will help you maximize your Kennametal scarifier blade performance:**

1. Kennametal recommends using only Grade 8, No. 3 head plow bolts and matching Grade 8 heavy hex nuts to install our scarifier blades.
2. Position and operate blades at a 90° angle to the road surface so cutting tools are at the proper cutting angle (see drawing on page 23).
3. Carbide-tipped cutting tools should be used to penetrate a depth no greater than 1.00" (25mm).
4. Inspect the blade and cutting tools daily. Replace lost, worn, or broken cutting tools immediately.
5. Kennametal carbide cutting tools are self-rotating and self-sharpening. Inspect cutting tools daily by turning them with your hand to ensure they are rotating properly. Cutting tools that do not turn can usually be freed by several light taps with a soft-headed hammer. Clean cutting tool and block assemblies with a solvent cleaner when necessary to ensure proper rotation of the cutting tool. Do not use oil for this purpose. Oil will cause dirt to adhere to the cutting tool, preventing proper rotation.
6. Do not use these blades to remove large rocks or boulders. These blades are intended for use in scarifying roads to return them to their original aggregate condition. Using Kennametal scarifier blades to remove large rocks or boulders terminates and voids all warranties and obligations from Kennametal as the manufacturer and supplier.
7. When transporting scarifier blades fitted with long-retainer cutting tools, be sure to roll the moldboard backward so the blade is horizontal and the cutting tools are pointed upward. This will prevent the cutting tools from vibrating out of the blade while in transit. This procedure is not necessary when using short-retainer cutting tools in the blade.
8. The travel speed of the grader may affect the performance of the blade. When working in heavy-impact applications, use a lower speed (such as second gear). This will reduce the risk of cutting tool breakage or blade damage.
9. "Backdragging" is not recommended. This procedure increases the risk of breakage or loss of cutting tools and puts unnecessary stress on the blade, bolts, and moldboard.
10. Use Kennametal carbide end protectors in applications like ditching that subject the side of the blade to wear. End protectors do not interfere with penetration and protect the ends of the blade from excessive wear.

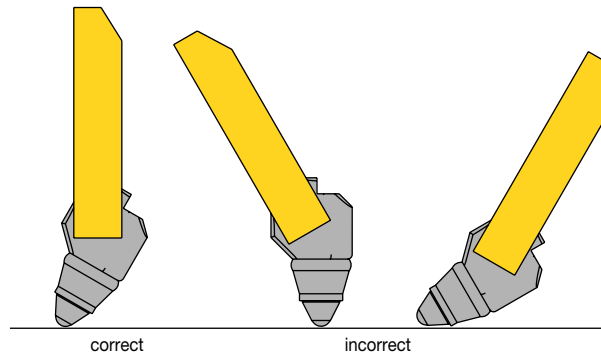

**To replace a worn or broken block:**

1. Cut out the broken block, if necessary, and clean the recess to remove rust and loose material.
2. Align the new block at the appropriate attack angle and tack weld into position.
3. Weld around the upper part of the block, first on the front and back side of the blade.
4. Use Airco 7018M or equivalent welding material.
5. Use a welding rod (stick) with a maximum .125" (3mm) diameter or a welding wire with a maximum .052" (1mm) diameter.
6. Angle the weld gun or rod to run a root pass along the block base where it meets the .500" (13mm) wide steel "tongue" between the blocks. Do not weld back and forth between the blocks. Run one pass on each side of the block in opposite directions to weld it to the blade.





# Dual-Carbide Blades

## Improved Braze, More Wear-Resistant Steel Body

Dual-carbide blades — available exclusively through Kennametal, the only manufacturer of this innovative blade — outlast embedded carbide granule-style blades. Dual-carbide blades features a universal bolt-hole and a variety of available lengths for maximum compatibility.

Dual-carbide tungsten insert blades are specifically designed for high-abrasion and low-impact applications to stay straight; maintain a sharp, clean edge; and stop crowning:

- First insert is formulated with our proprietary macrocrystalline carbide grade for toughness and impact resistance and mounts on the front of blade.
  - Second insert is made from a wear-resistant carbide grade and mounts directly behind the first insert to resist wear caused by blade down pressure and abrasion.
- Backed by a comprehensive warranty program.

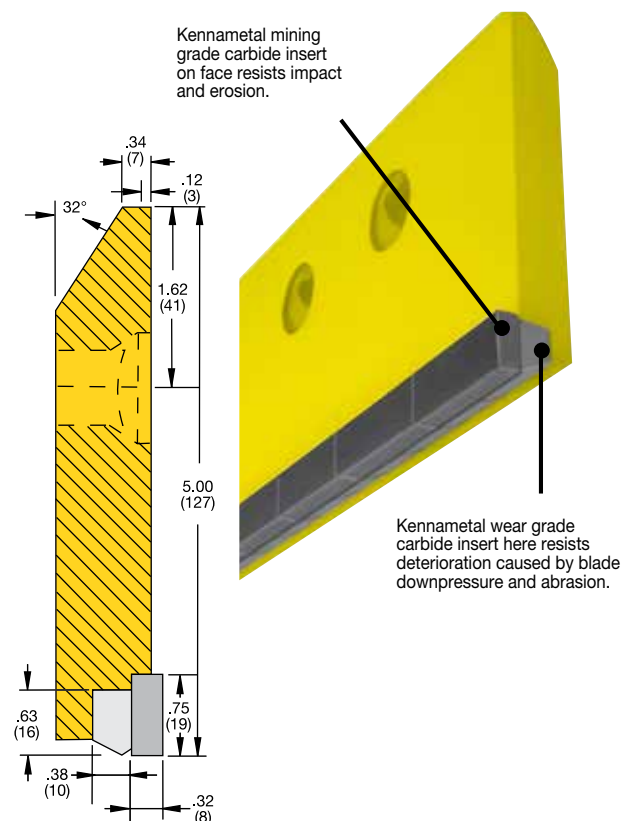

# Specifications

- Steel holder:** SAE 1040-1045, hot-rolled
- Carbide inserts:**
- Front .750" (19mm) high, impact-resistant
  - Rear .625" (16mm) high, wear-resistant
- Braze:** A high-strength alloy material

## Bolting Recommendations

To reduce the likelihood of blade chatter and/or failure, use Grade 8, Number 3 head plow bolts and nuts.

## Hole-Punch Data

- Standard 6" (152mm) on centers
- .687" (17mm) square, countersunk to receive .625" (16mm) diameter plow bolts

## OR

- .812" (21mm) square, countersunk to receive 750" (19mm) diameter plow bolts
- Holes accurately punched to fit most make/models of graders.

## ■ Dual-Carbide Blade Sizes and Ordering Information

thickness		width		length (L)		order number	bolt diameter		weight	
in	mm	in	mm	in	mm		in	mm	kg	lbs
.875	22	5	127	24	610	<b>1011871</b>	.625	16	15	32
.875	22	5	127	36	914	<b>1011872</b>	.625	16	22	48
.875	22	5	127	48	1219	<b>1011875</b>	.625	16	29	63
.875	22	5	127	36	914	<b>1011879</b>	.750	19	22	48
.875	22	5	127	48	1219	<b>1011877</b>	.750	19	29	63
.875	22	5	127	60	1524	<b>1311238</b>	.625	16	35	77

NOTE: When ordering, please provide the order number and be sure to specify hole size and moldboard length. Blades beveled at top to fit grader moldboard.



## DCI Cover Blades — Now 3/4" (19mm) thick

When operating in extremely abrasive conditions, our optional cover blades provide added wear resistance for the non-carbide portion of the blade. The chamfered bottom edge inhibits any interruption of the rolling action of bladed road material. The cover blades are attached using the same bolts as those used for attaching the dual-carbide blade below it, simply by increasing the length of the bolts by a .500" (13mm). It's not necessary to use end protectors when cover blades are used. Fabricated from wear-resistant steel, these cover blades are available in the following sizes:

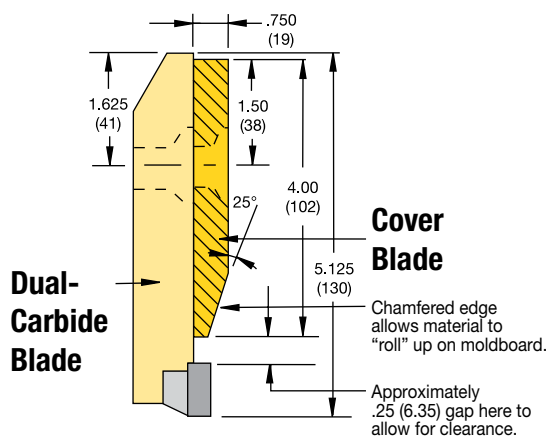

### Thick Dual Carbide Cover Blades Ordering Information 3/4" (19mm)

thickness		width		length		order number	bolt diameter	
in	mm	in	mm	in	mm		in	mm
.750	19	4	102	36	914	2492564	.625	16
.750	19	4	102	48	1219	2478681	.625	16
.750	19	4	1102.27	36	914	2872390	.750	19

\* Replaces old 1/2" (13mm) thick blade part numbers.

# End Protectors

Kennametal highly recommends the use of our carbide or standard steel end protectors. Our end protectors avoid impact damage by covering the last 9" (229mm) of each of the end blades on either side of the moldboard. They are installed over the dual carbide blade, using the same bolt holes (as shown in the diagram). An installation guide is available upon request.

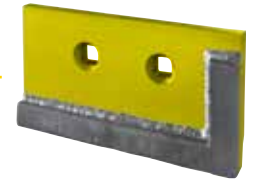

carbide type shown

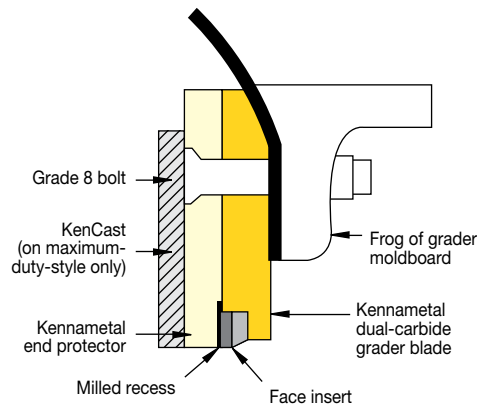

## Blade Selection Guide for Various Moldboards Lengths

standard steel type	
new order number	description
1011918	standard for .625 (16) bolts
1011919	standard for .750 (19) bolts

standard steel type	
new order number	description
1012555	maximum-duty right for .625 (16) bolts
1012556	maximum-duty right for .750 (19) bolts
1012560	maximum-duty left for .625 (16) bolts
1012561	maximum-duty left for .750 (19) bolts



## I.C.E.™ /KenCoat™ Blades Snowplow/Grader Blades — Two Unique Technologies Combined into One

Traditional carbide-edged blades are prone to premature failure in tough, high-impact applications because cracks that occur in a single carbide insert often travel the length of the blade through all the carbide inserts. Kennametal's I.C.E./KenCoat blades eliminate total blade fractures and provide one of the strongest carbide blades available today!

I.C.E./KenCoat blades withstand blade edge breakage and damage caused by the harshest road conditions, aggressively cutting through hard-packed road surfaces. Within one blade, we combine the durable, individually mounted bullet-shaped inserts of the I.C.E. Series™ with KenCoat wear-resistant carbide granules imbedded in a tough, abrasion-resistant, steel-weld material. Together, these two technologies provide the ultimate in blade strength, performance, and longevity.

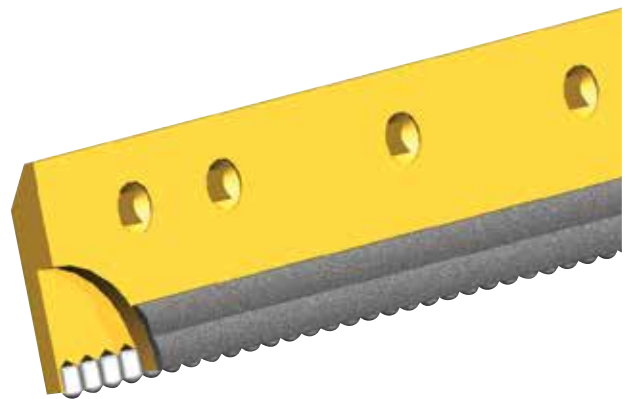

# When the going gets tough... get our tough I.C.E.™ /KenCoat™ blades

I.C.E./KenCoat blades feature a row of .500" (13mm) diameter, .750" (19mm) high, bullet-shaped tungsten carbide inserts on the wear edge of the blade and a 1.50" (38mm) wide band of KenCoat carbide in front of the inserts.

- Combines durable, individually mounted bullet-shaped inserts protected with a layer of wear-resistant carbide granules imbedded in a tough, abrasion-resistant, steel-weld material in one blade.
- Offers maximum blade strength and blade longevity — even in the harshest of road applications.
- Features the highest levels of combined blade wear, impact, and fracture resistance.
- Performs effectively to remove snow on roads with imbedded lane markers and rumble strips by effectively resisting carbide fractures.
- Improved penetration versus traditional straight edged designs.

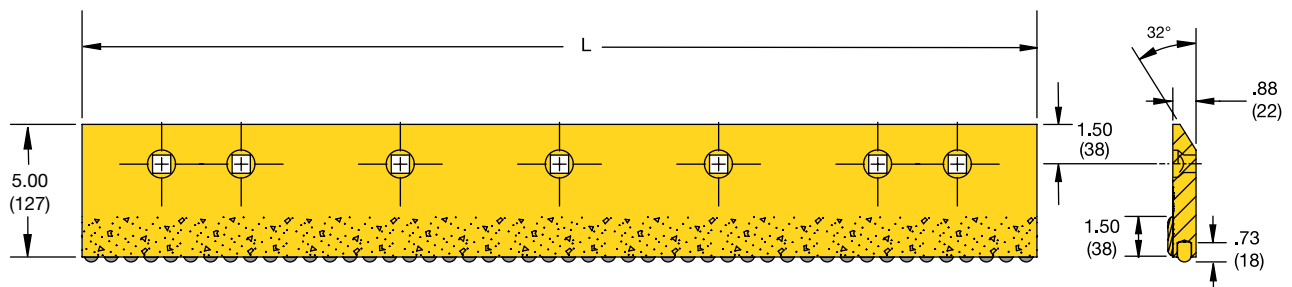

## ■ I.C.E./KenCoat Blade Sizes and Ordering Information

thickness		width		length		order number	bolt diameter		weight	
in	mm	in	mm	in	mm		in	mm	kg	lbs
.875	22	5	127	36	914	<b>1923523</b>	.625	16	20	45
.875	22	5	127	48	1219	<b>1923524</b>	.625	16	27	60
.875	22	5	127	36	914	<b>2388888</b>	.750	19	20	45
.875	22	5	127	48	1219	<b>2388889</b>	.750	19	27	60



# KenCoat™ Blades

## Kennametal Carbide Overlay Application Technology

KenCoat Grader Blades use our exclusive Kennametal Carbide Overlay Application Technology to fortify the mild steel face of standard carbide insert blades, providing enhanced blade protection and strength.

When working on unpaved surfaces, the mild steel of standard carbide insert blades often wears away, weakening the carbide insert and making it susceptible to impact and breakage. KenCoat Grader Blades are economical choices to prevent this type of wear.





The KenCoat layer consists of wear-resistant carbide granules embedded in a tough, abrasion-resistant, steel-weld material and protects a solid carbide insert that is brazed in place and resists wear from down pressure.

KenCoat Grader Blades are .875" (22mm) thick and 5" (127mm) wide (tall). They are available in both standard 36" (914mm) and widepass 48" (1219mm) lengths and fit all makes and models of graders.

- Economical choices for moderate-impact applications.
- Provides enhanced blade protection and resistance to wear caused by down pressure.
- Features wear-resistant carbide granules embedded in an abrasion-resistant, steel-weld material.
- Available in 1" (25mm) wide and 1-1/2" (38mm) wide KenCoat protection.
- Fits all makes and models of graders.

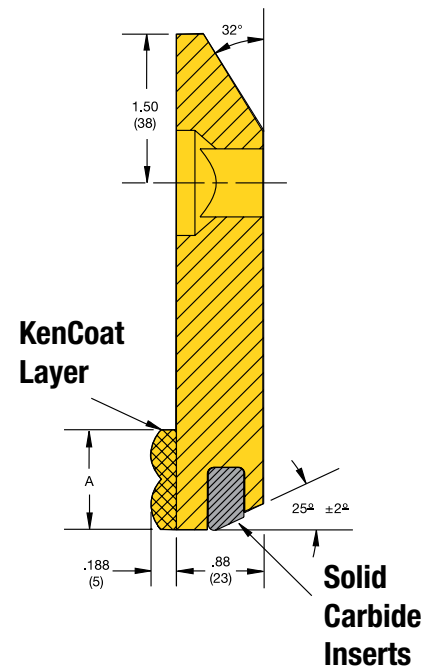
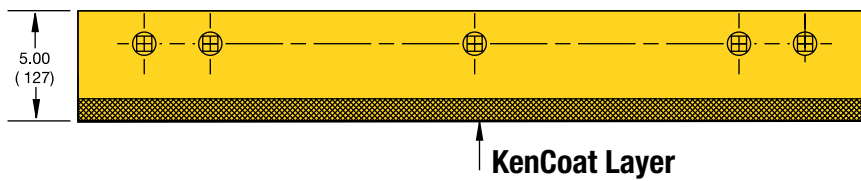

■ KenCoat Blade Sizes and Ordering Information • Wide KenCoat Protection 1" (25mm)

thickness		width		length		order number	bolt diameter		weight		Size A	
in	mm	in	mm	in	mm		in	mm	kg	lbs	in	mm
.875	22	5	127	36	914	<b>1231173</b>	.625	16	20	45	1.00	25
.875	22	5	127	48	1219	<b>1180020</b>	.625	16	27	60	1.00	25
.875	22	5	127	48	1219	<b>1728718</b>	.750	19	27	60	1.00	25

■ KenCoat Blade Sizes and Ordering Information • Wide KenCoat Protection 1-1/2" (38mm)

thickness		width		length		order number	bolt diameter		weight		Size A	
in	mm	in	mm	in	mm		in	mm	kg	lbs	in	mm
.875	22	5	127	36	914	<b>2619561</b>	.625	16	20	45	1.50	38
.875	22	5	127	48	1219	<b>2619509</b>	.625	16	27	60	1.50	38
.875	22	5	127	60	1524	<b>2619556</b>	.625	16	34	75	1.50	38
.875	22	5	127	36	914	<b>2619559</b>	.750	19	20	45	1.50	38
.875	22	5	127	48	1219	<b>2619560</b>	.750	19	27	60	1.50	38

NOTE: Blades utilize a row of 5/8" (16mm) high trapezoid-shaped tungsten carbide inserts on the wear edge.



## Armored Blades

### Hardened-Steel Armored Blades

Kennametal Armored Blades are designed to provide better protection of the steel face of standard carbide insert blades. When working on unpaved surfaces, the mild steel can deteriorate, exposing the carbide insert to greater impact and causing blade breakage. Kennametal Armored Blades are the economical choice to prevent this type of wear.

Kennametal Armored Blades use a securely welded, hardened-steel plate to protect and further strengthen the inserts. The wear-resistant, armored blades are .875" (22mm) thick in the bolt area and 1.0625" (27mm) thick in the armor plate area. The blades are 5" wide (127mm) (tall) and are available in 36" (914mm), 48" (1219mm), and 60" (1524mm) lengths.

Like all Kennametal grader blades, they are "standard highway punched" to fit all makes and models of graders.

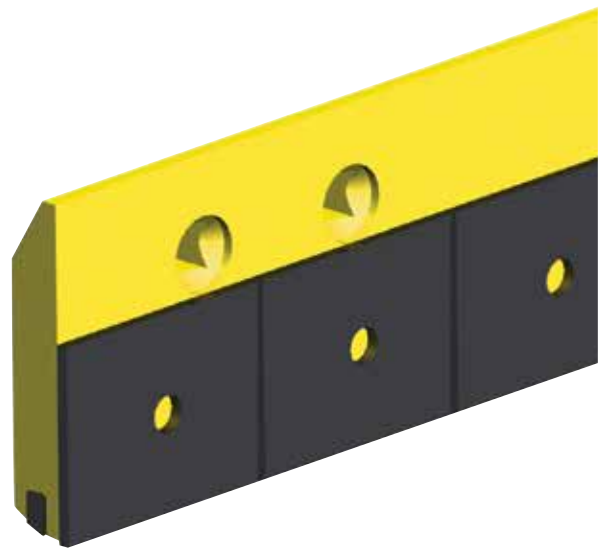

- Economical choices for higher-impact applications.
- Protects carbide insert by reinforcing the steel face with a securely welded, hardened-steel plate.
- Reduces blade wear caused by unpaved surfaces, extending blade life by three to five times as compared to standard carbide blades.
- Available in 3ft (914mm), 4ft (1219mm), and 5ft (1524mm) lengths.
- “Standard highway punched” to fit all makes and models.

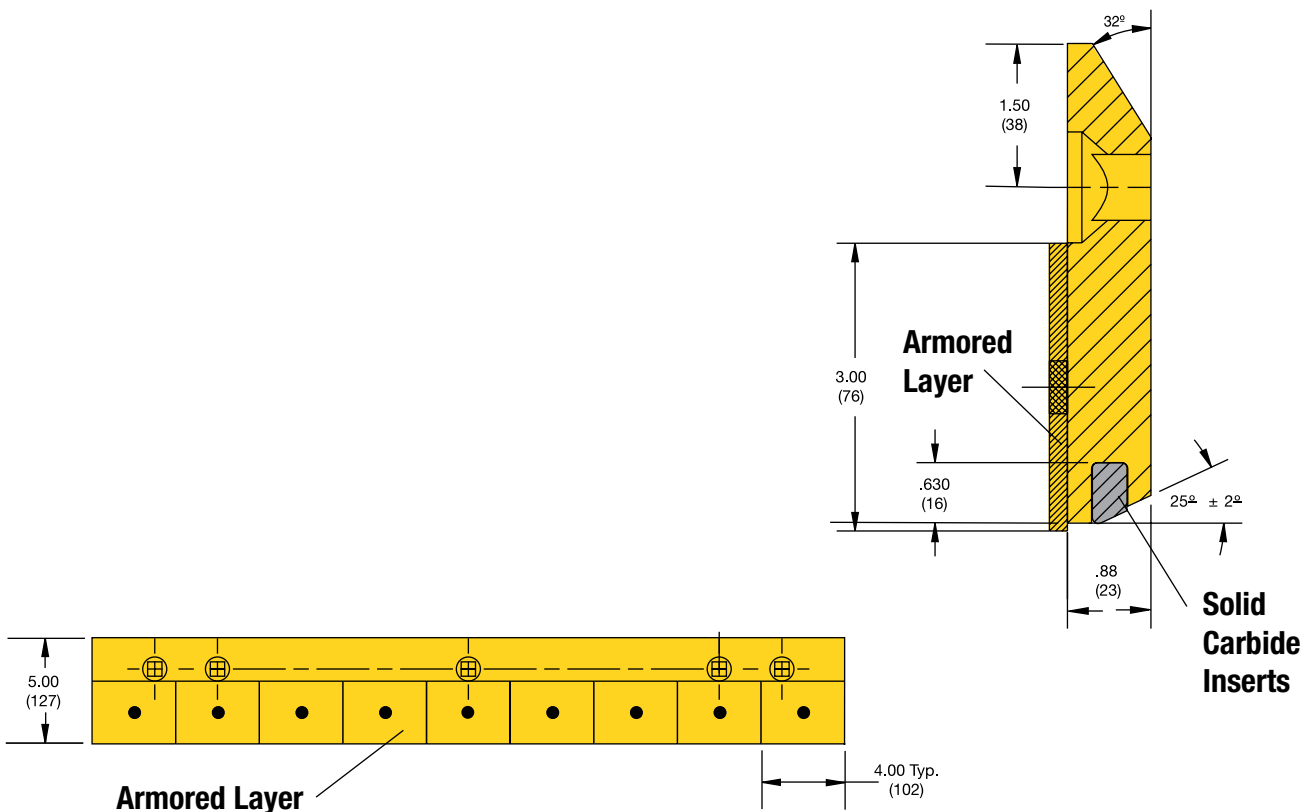

### ■ Armored Blades Ordering Information

thickness		width		length		order number	bolt diameter		weight	
in	mm	in	mm	in	mm		in	mm	kg	lbs
.875	22	5	127	36	914	<b>1105976</b>	.625	16	21	47
.875	22	5	127	48	1219	<b>1013304</b>	.625	16	29	63

### ■ Replacement Wear Patch

thickness		width		length		order number	bolt diameter		weight	
in	mm	in	mm	in	mm		in	mm	kg	lbs
.875	5	3	76	4	102	<b>1012159</b>	—	—	.005	.01



# Snow Removal Blades

## Tungsten Carbide-Edged Blades for Graders, Equipped with Front Plows or Wings, and Underbody Plows

Our tungsten carbide-edged grader blades stand up against the toughest winter snow-packed roads.

Equipped with genuine Kennametal tungsten carbide inserts, which are secured firmly to the blade with our superior brazing technique, these snowplow blades offer unparalleled fracture and wear resistance. In fact, our tungsten carbide-edged snowplow blades are field tested and proven to have a life span 20 times greater than competitive all-steel blades.

Kennametal tungsten carbide-edged snowplow blades are available in a variety of lengths in two styles: standard-size .625" (16mm) carbide inserts and heavy-duty .750" (19mm) carbide inserts.

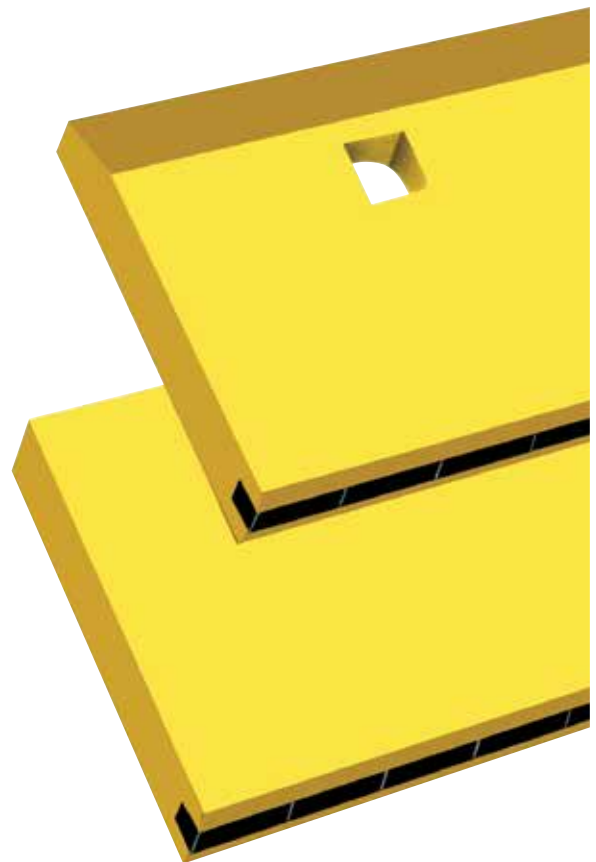

- Economically priced blades for paved road surfaces.
- Features genuine Kennametal tungsten carbide inserts formulated with macrocrystalline technology.
- Provides superior wear-resistance and longevity, outlasting competitive all-steel blades by up to 20:1.
- Our brazing expertise ensures that inserts stay firmly in place, without residual stress, resulting in a more durable blade.
- Available in an unmatched variety of styles and size — all backed by the road maintenance industry’s best quality assurance program.
- Sold in combinations of 3ft (914mm) or 4ft (1219mm) lengths for more versatility, safety, and ease of use.

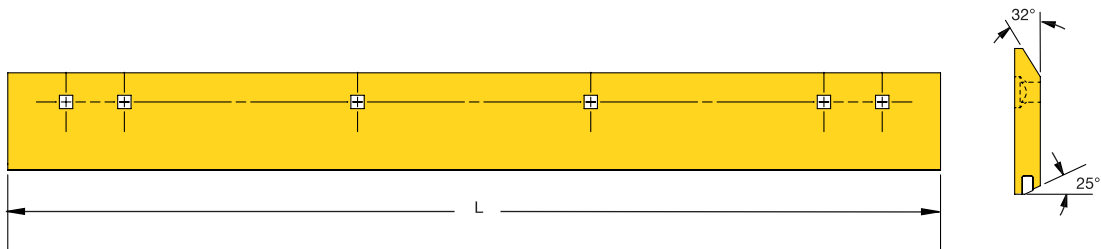

■ Snowplow Blades Ordering Information • Standard Size .625" (16mm) Carbide Inserts

thickness		width		length (L)		order number	catalog number	bolt hole distance		hole spacing		weight	
in	mm	in	mm	in	mm			in	mm	in	mm	kg	lbs
.875	22	5	127	36	914	1011883	PB-736H top beveled	1.50	38	3-3-12-12-3-3	76-76-305-305-76-76	18	40
.875	22	5	127	48	1219	1011885	PB-748H top beveled	1.50	38	3-3-12-12-12-3-3	76-76-305-305-305-76-76	25	55
.875	22	5	127	60	1524	1011887	PB-760H top beveled	1.50	38	3-3-12-12-12-12-3-3	76-76-305-305-305-305-76-76	32	70

■ Snowplow Blades Ordering Information • Heavy-Duty Size .750" (19mm) Carbide Inserts

thickness		width		length (L)		order number	catalog number	bolt hole distance		hole spacing		weight	
in	mm	in	mm	in	mm			in	mm	in	mm	kg	lbs
.875	22	5	127	48	1219	1011930	GDR48A0140	1.50	38	3-3-12-12-12-3-3	76-76-305-305-305-76-76	26	57



**Kennametal Inc. encourages the safe use of its products. To help avoid personal injury or damage to tools, please follow these guidelines:**

- Wear approved personal protection equipment, including eye and ear protection, steel-toed shoes, hard hat, and vest.
- Make sure tools are properly seated and securely retained.
- Do not strike cutting tools with metal objects. Carbide tips could shatter.
- Use a soft-headed hammer or other approved installation tools to insert cutting tools.
- Exercise care when removing tools.
- Inspect tools before each use. Do not use dull, cracked, burred, or bent tools.
- Operate all machines with safety in mind. Stand clear of machines in use, and make sure protective guards are in place.
- Do not change tools when the blade is moving.





**Argentina**

Phone: +54 11 4719 0700

Fax: +54 11 4719 6116

**Australia/New Zealand**

Phone: +61 7 3801 5844

Fax: +61 7 3801 5826

k-sydn.service@kennametal.com

**Brazil/Latin America**

Phone: +55 19 3936 9200

Fax: +55 19 3936 9201

bra.marketing@kennametal.com

**Chile**

Phone: +56 2 2641177

Fax: 001 888 442 4964

**China**

Phone: +86 400 650 1388

Fax: +86 10 8561 5263

k-cn-earthwork.service@kennametal.com

**Germany/European Served Area**

Phone: +49 6172 737 498

Fax: +49 6172 737 42 453

mcs-ag.service@kennametal.com

**India**

Phone: +91 800 22198444

Phone: +91 080 43281444

Fax: 91 80 2839 1300

bangalore.information@kennametal.com

**Japan**

Phone: +81 3 3820 2855

Fax: +81 3 3820 2800

k-jp.service@kennametal.com

**Korea**

Phone: +82 2 2109 6100

Fax: +82 2 2109 6981

**Malaysia**

Phone: 6 03 5569 9080

Fax: 6 03 5569 0080

**Poland/Slovakia/Baltics**

Phone: +48 61 665 6520

Fax: +48 61 665 6521

zory.orders@kennametal.com

**South Africa/Sub Saharan Area**

Phone: +27 11397 3540

Fax: +27 11397 3222

**Singapore/Vietnam/  
Philippines/Indonesia**

Phone: +65 6265 9222

Fax: +65 6861 0922

k-sg.sales@kennametal.com

**Thailand**

Phone: +66 2642 3455

Fax: +66 2641 2736-8

**United States/Canada/Mexico**

Phone: 800 458 3608

Fax: 800 521 3319

mcs-na.service@kennametal.com

Kennametal, the stylized K, KenCast, I.C.E., and KenCoat, are registered trademarks of Kennametal Inc. and are used as such herein. The absence of a product or service name or logo from this list does not constitute a waiver of Kennametal's trademark or other intellectual property rights concerning that name or logo.

Copyright 2015 by Kennametal Inc., Latrobe, PA 15650. All rights reserved.

**WORLD AND CORPORATE HEADQUARTERS**

**Kennametal Inc.**

1600 Technology Way  
Latrobe, PA 15650 USA  
Phone: 800 446 7738 (United States and Canada)  
E-mail: [ftmill.service@kennametal.com](mailto:ftmill.service@kennametal.com)

**EUROPEAN HEADQUARTERS**

**Kennametal Europe GmbH**

Rheingoldstrasse 50  
CH 8212 Neuhausen am Rheinfall  
Switzerland  
Phone: +41 52 6750 100  
E-mail: [neuhausen.info@kennametal.com](mailto:neuhausen.info@kennametal.com)

**ASIA-PACIFIC HEADQUARTERS**

**Kennametal Singapore Pte. Ltd.**

3A International Business Park  
Unit #01-02/03/05, ICON@IBP  
Singapore 609935  
Phone: +65 6265 9222  
E-mail: [k-sg.sales@kennametal.com](mailto:k-sg.sales@kennametal.com)

**INDIA HEADQUARTERS**

**Kennametal India Limited**

CIN: L27109KA1964PLC001546  
8/9th Mile, Tumkur Road  
Bangalore - 560 073  
Phone: +91 080 22198444 or +91 080 43281444  
E-mail: [bangalore.information@kennametal.com](mailto:bangalore.information@kennametal.com)



Kennametal Inc.  
1600 Technology Way  
Latrobe, PA 15650  
USA

[www.kennametal.com](http://www.kennametal.com)